

**Fast Recovery
Diode
Type SA35ML2698Z0**

Contact us!

Date: February, 2020
Data Sheet Issue: 1

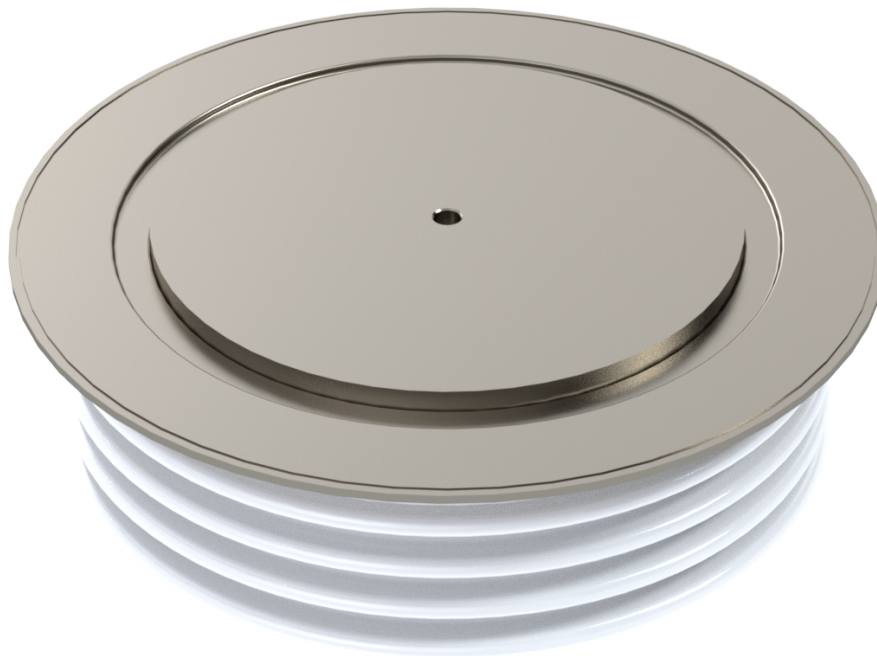

ORDERING INFORMATION

(Please quote 12 to 15 digit code as below)

SA	35	ML	2698	Z	0	
-	Voltage Code	MP : standard capsule MG : rupture rated capsule ML : extended rupture rated capsule	Current code	Type code	Special code	Optional code

Find more!

Explore the full range of our semiconductor portfolio online

Absolute Maximum Ratings

VOLTAGE RATINGS		MAXIMUM LIMITS	UNITS
V_{RRM}	Repetitive peak reverse voltage, (note 1)	3500	V
V_{RSM}	Non-repetitive peak reverse voltage, (note 1)	3600	V
V_{RDC}	Maximum reverse D.C. Voltage, (note 1)	1900	V
note 1)	De-Rating factor of 0.13% per °C is applicable for T_j below 25°C		

OTHER RATINGS		MAXIMUM LIMITS	UNITS
$I_{F(AV)M}$	Maximum average forward current, $T_{sink} = 55^\circ\text{C}$, (note 1)	2698	A
$I_{F(AV)M}$	Maximum average forward current, $T_{sink} = 100^\circ\text{C}$, (note 1)	1825	A
$I_{F(AV)M}$	Maximum average forward current, $T_{sink} = 100^\circ\text{C}$, (note 2)	1165	A
$I_{F(RMS)}$	Nominal RMS forward current, $T_{sink} = 25^\circ\text{C}$ (note 1)	4979	A
$I_{f(d.c.)}$	D.C. forward current, $T_{sink} = 25^\circ\text{C}$ (note 3)	4545	A
I_{FSM}	Peak non-repetitive surge current $t_p = 10\text{ms}$, $V_{RM} = 60\%V_{RRM}$, (note 4)	27.8	kA
I_{FSM2}	Peak non-repetitive surge current $t_p = 10\text{ms}$, $V_{RM} \leq 10\text{V}$, (note 4)	30.6	kA
I^2t	I^2t capacity for fusing $t_p = 10\text{ms}$, $V_{RM} = 60\%V_{RRM}$, (note 4)	$3.86 \cdot 10^6$	A^2s
I^2t	I^2t capacity for fusing $t_p = 10\text{ms}$, $V_{RM} \leq 10\text{V}$, (note 4)	$4.68 \cdot 10^6$	A^2s
T_{jop}	Operating temperature range	-40 to +150	°C
T_{stg}	Storage temperature range	-40 to +150	°C
note 1)	Double-side cooled, single phase, 50Hz, 180° half-sinewave.		
note 2)	Single-side cooled, single phase, 50Hz, 180° half-sinewave.		
note 3)	Double-side cooled.		
note 4)	Half-sinewave, 150°C T_j initial.		

Characteristics

PARAMETER	TEST CONDITIONS	MIN	TYP	MAX	UNITS	
V _{FM}	Maximum peak forward voltage	I _{FM} =6000A	-	-	3.0	V
		I _{FM} =5400A	-	-	2.9	V
V _{T0}	Threshold Voltage	-	-	1.00	V	
r _T	Slope resistance	-	-	0.33	mΩ	
V _{FRM}	Maximum forward recovery voltage	di/dt = 1000A/μs, T _j = 25°C	-	-	20	V
		di/dt = 1000A/μs	-	-	45	V
I _{RRM}	Peak reverse current	Rated V _{RRM}	-	-	150	mA
Q _{rr}	Recovered charge		-	1200	-	μC
Q _{ra}	Recovered charge, 50% Chord	I _{FM} = 1000A, t _p = 1000μs, di/dt = 60A/μs, V _R = 50V, 50% Chord.	-	620	800	μC
I _{rm}	Reverse recovery current		-	200	-	A
t _{rr}	Reverse recovery time, 50% Chord		-	6.2	-	μs
R _{thJK}	Thermal resistance, junction to heatsink	Double side cooled	-	-	0.011	K/W
		Single side cooled	-	-	0.022	K/W
F	Mounting force	note 2)	37	-	47	kN
W _t	Weight		-	1700	-	g
note 1)	Unless otherwise indicated T _j = 150°C					
note 2)	For other clamp forces consult factory					

Request full technical data sheet via e-mail, free of charge:

Order Now!

Outline Drawing

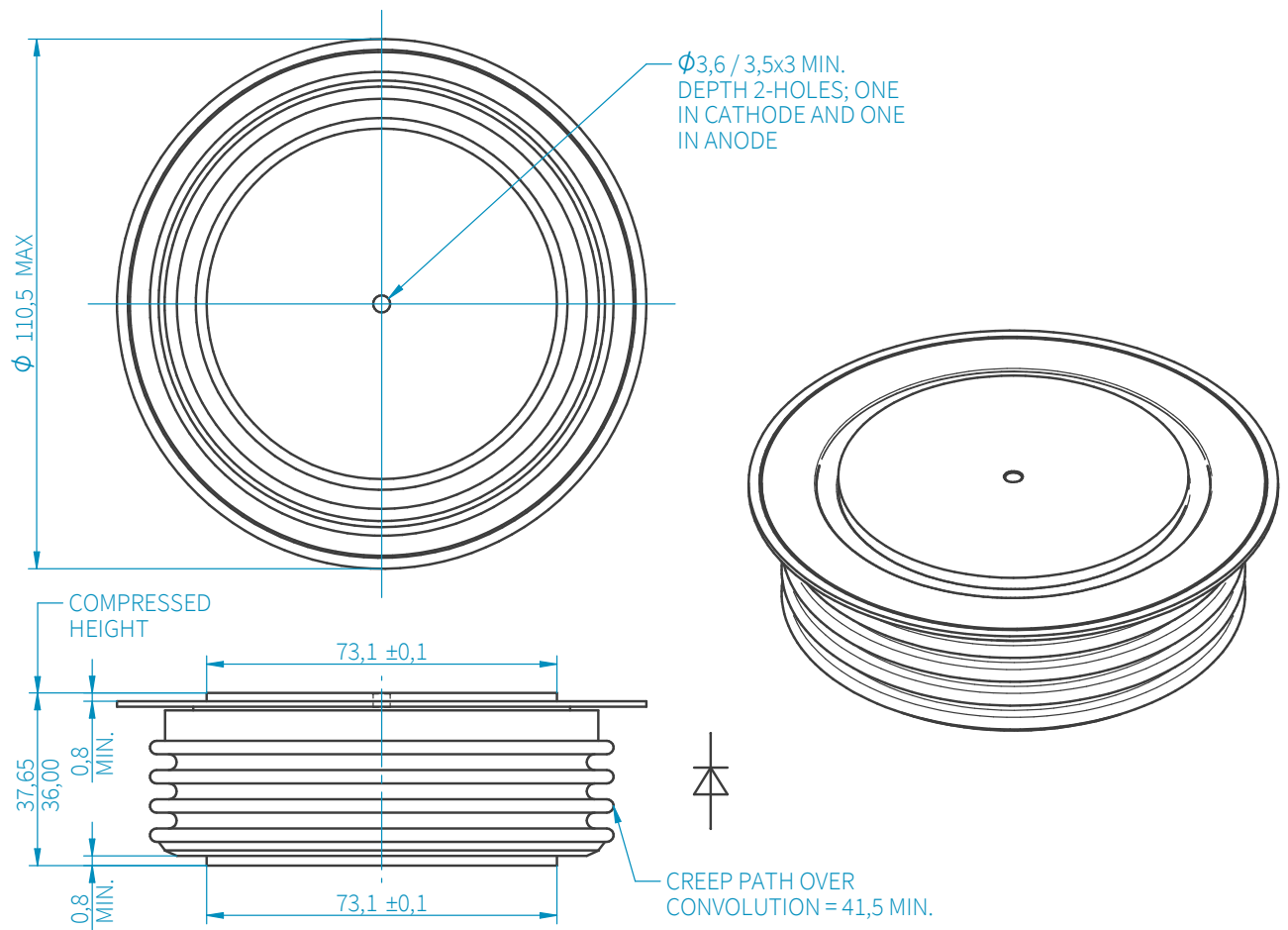

SANCONA®

technical solutions

SANCONA GmbH

An der Hebemärchte 26
D-04316 Leipzig

// ☎ +49 341 652355-0
 // 📠 +49 341 652355-99
 // ✉ info@sancona.com
 // 🌐 www.sancona.com

// Registry Court: Leipzig HRB 32946
 VAT Reg No.: DE308741810
 Tax number: 232/118/085686

The information contained herein is confidential and is protected by Copyright. The information may not be used or disclosed except with written permission of and in the manner permitted by the proprietors SANCONA GmbH. In the interest of product improvement, SANCONA reserves the right to change specifications at any time without prior notice. Devices with a suffix code (2-letter, 3-letter or letter/digit/letter combination) added to their generic code are not necessarily subject to the conditions and limits contained in this report.