

Fast Symmetrical Gate Turn-Off Thyristor Type SA25XP0500FY

SANCONA[®]
Technical solutions

Contact us!

Date: May , 2020
Data Sheet Issue: 1

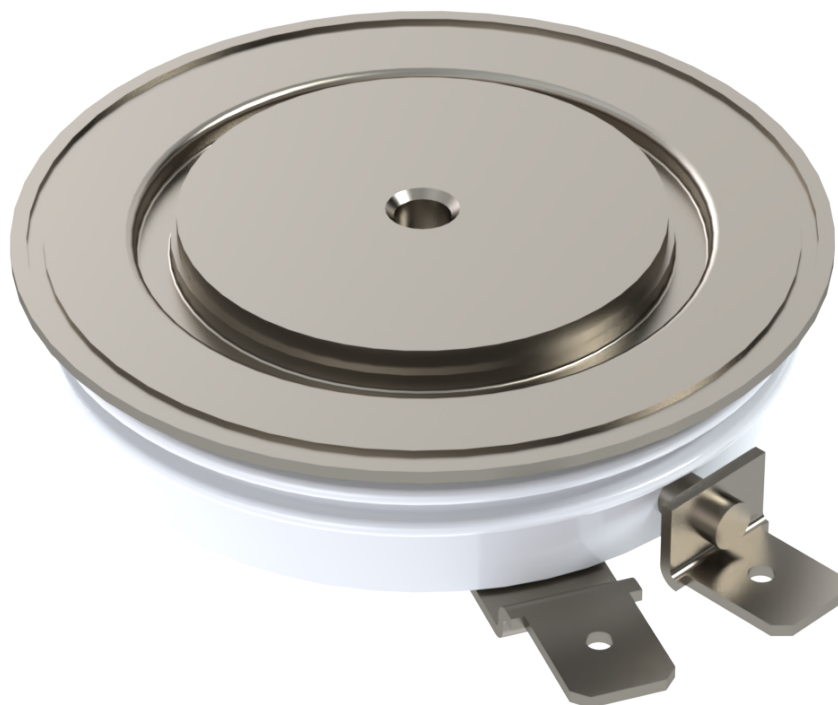

ORDERING INFORMATION

(Please quote 12 to 15 digit code as below)

SA	25	XP	0500	F	Y	
-	Voltage Code	Outline Code	Current code	Type code	Special code	Optional code

Find more!

Explore the full range of our semiconductor portfolio online

Absolute Maximum Ratings

VOLTAGE RATINGS		MAXIMUM LIMITS	UNITS
V_{DRM}	Repetitive peak off-state voltage, (note 1)	2500	V
V_{RSM}	Non-repetitive peak off-state voltage, (note 1)	2600	V
V_{RRM}	Repetitive peak reverse voltage	100	V
V_{RSM}	Non-repetitive peak reverse voltage	100	V
note 1)	$V_{GK} = -2V$		

OTHER RATINGS		MAXIMUM LIMITS	UNITS
I_{TGQ}	Peak turn-off current (note 1)	500	A
L_S	Snubber loop impedance, $I_{TM} = I_{TGQ}$ (note 1)	0.3	nH
$I_{T(AV)M}$	Mean on-state current, $T_{sink} = 55^{\circ}C$, (note 2)	330	A
$I_{T(RMS)}$	Nominal RMS on-state current, $T_{sink} = 25^{\circ}C$ (note 2)	640	A
I_{TSM}	Peak non-repetitive surge current $t_p = 10ms$	4.0	kA
I_{TSM2}	Peak non-repetitive surge current (note 3)	7.2	kA
I^2t	I^2t capacity for fusing $t_p = 10ms$	$80 \cdot 10^3$	A^2s
$(di/dt)_{cr}$	Critical rate of rise of on-state current, (note 4)	1000	$A/\mu s$
P_{FGM}	Peak forward gate power	160	W
P_{RGM}	Peak reverse gate power	5	kW
I_{FGM}	Peak forward gate current	100	A
V_{RGM}	Peak reverse gate voltage (note 5)	18	V
t_{off}	Minimum permissible off-time, $I_{TM} = I_{TGQ}$ (note 1)	90	μs
t_{on}	Minimum permissible on-time	20	μs
T_{jop}	Operating temperature range	-40 to +125	$^{\circ}C$
T_{stg}	Storage temperature range	-40 to +150	$^{\circ}C$
note 1)	$T_j = 125^{\circ}C$, $V_D = 80\%V_{DRM}$, $V_{DM} \leq V_{DRM}$, $di_{GQ}/dt = 20A/\mu s$, $C_S = 1\mu F$		
note 2)	Double-side cooled, single phase, 50Hz, 180° half-sinewave.		
note 3)	Half-sinewave, $t_p = 2ms$		
note 4)	For $di/dt > 1000A/\mu s$ please consult factory.		
note 5)	May exceed this value during turn-off avalanche period.		

Characteristics

PARAMETER	TEST CONDITIONS	MIN	TYP	MAX	UNITS	
V_{TM}	Maximum peak on-state voltage	$I_G = 2A, I_T = 500A$	-	2	2.5	V
I_L	Latching current	$T_j = 25^\circ C$	-	5	-	A
I_H	Holding current		-	5	-	A
$(dv/dt)_{cr}$	Critical rate of rise of off-state voltage	$V_D = 80\%V_{DRM}, V_{GR} = -2V$	1000	-	-	V/ μs
I_{DRM}	Peak off-state current	Rated $V_{DRM}, V_{GR} = -2V$	-	-	30	mA
I_{RRM}	Peak reverse current	Rated V_{RRM}	-	-	60	mA
I_{GKM}	Peak negative gate leakage current	$V_{GR} = -16V$	-	-	200	mA
V_{GT}	Gate trigger voltage	$T_j = -40^\circ C, V_D = 25V, R_L = 25m\Omega$	-	0.9	-	V
		$T_j = 25^\circ C, V_D = 25V, R_L = 25m\Omega$	-	0.8	-	V
		$T_j = 125^\circ C, V_D = 25V, R_L = 25m\Omega$	-	0.7	-	V
I_{GT}	Gate trigger current	$T_j = -40^\circ C, V_D = 25V, R_L = 25m\Omega$	-	1.5	6	A
		$T_j = 25^\circ C, V_D = 25V, R_L = 25m\Omega$	-	0.5	2	A
		$T_j = 125^\circ C, V_D = 25V, R_L = 25m\Omega$	-	0.1	0.4	A
t_d	Delay time	(note 2)	-	1.5	-	μs
t_{gt}	Turn-on time	Conditions as for t_d , (10% I_{GM} to 10% V_D)	-	3.5	5	μs
t_f	Fall time	(note 3)	-	0.8	-	μs
t_{gq}	Turn-off time	Conditions as for t_f , (10% I_{GQ} to 10% I_{TGQ})	-	10	11	μs
I_{GQ}	Turn-off gate current	Conditions as for t_f	-	185	-	A
Q_{GQ}	Turn-off gate charge		-	1200	1330	mC
t_{tail}	Tail time	Conditions as for t_f , (10% I_{TGQ} to $I_{TGQ} < 1A$)	-	50	75	μs
t_{gw}	Gate off-time (note 4)	Conditions as for t_f	150	-	-	μs
R_{thJK}	Thermal resistance, junction to sink	Double side cooled	-	-	0.065	kW
		Cathode side cooled	-	-	0.24	kW
		Anode side cooled	-	-	0.09	kW
F	Mounting force	(note 5)	4.5	-	9.0	kN
W_t	Weight		-	120	-	g
note 1)	Unless otherwise indicated $T_j = 125^\circ C$					
note 2)	$V_D = 50\%V_{DRM}, I_{TGQ} = 500A, I_{GM} = 10A, di_G/dt = 5A/\mu s, T_j = 25^\circ C, di/dt = 300A/\mu s, (10\%I_{GM} \text{ to } 90\%V_D)$					
note 3)	$V_D = 80\%V_{DRM}, I_{TGQ} = 500A, C_S = 1\mu F, di_G/dt = 20A/\mu s, V_{GR} = -16V, (90\%I_{TGQ} \text{ to } 10\%I_{TGQ})$					
note 4)	The gate off-time is the period during which the gate circuit is required to remain low impedance to allow for the passage of tail current.					
note 5)	For other clamping forces, consult factory.					

Request full technical data sheet via e-mail, free of charge:

Order Now!

Outline Drawing

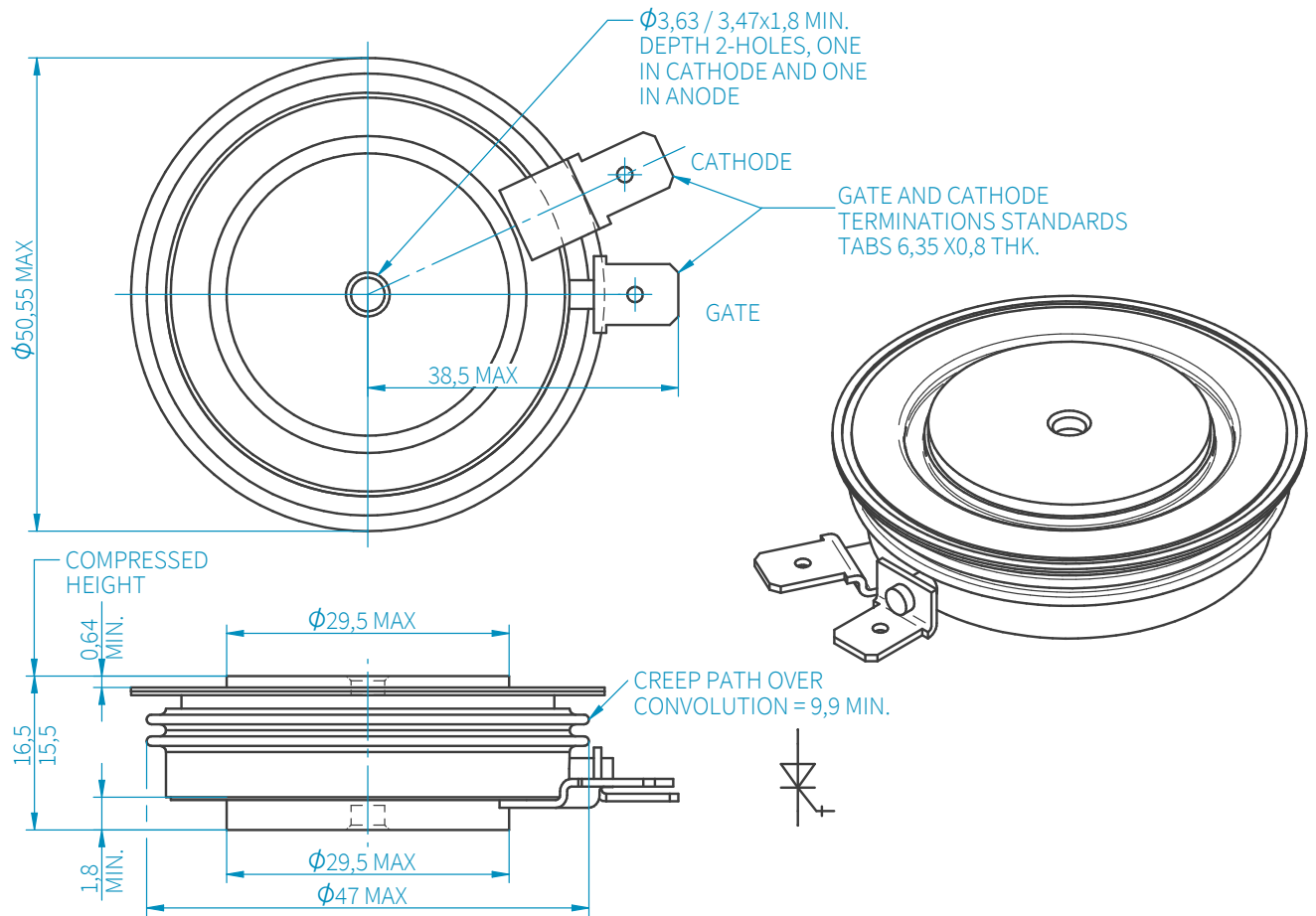

SANCONA®

technical solutions

SANCONA GmbH

An der Hebemärchte 26
D-04316 Leipzig

// ☎ +49 341 652355-0
 ☎ +49 341 652355-99
 ✉ info@sancona.com
 🌐 www.sancona.com

// Registry Court: Leipzig HRB 32946
 VAT Reg No.: DE308741810
 Tax number: 232/118/085686

The information contained herein is confidential and is protected by Copyright. The information may not be used or disclosed except with written permission of and in the manner permitted by the proprietors SANCONA GmbH. In the interest of product improvement, SANCONA reserves the right to change specifications at any time without prior notice. Devices with a suffix code (2-letter, 3-letter or letter/digit/letter combination) added to their generic code are not necessarily subject to the conditions and limits contained in this report.